

## DS-7608NXI-K2 AcuSense NVR

### Key Feature

- Up to 8-ch IP camera inputs
- H.265+/H.265/H.264+/H.264 video formats
- Up to 2-ch@12 MP or 3-ch@8 MP or 6-ch@4 MP or 12-ch@1080p decoding capacity
- Up to 80 Mbps incoming bandwidth
- Adopt Hikvision Acusense technology to minimize manual effort and security costs



### Smart Function

- All channels support Motion Detection 2.0
- 1-ch facial recognition for video stream, or 4-ch facial recognition for face picture
- Smart search for the selected area in the video, and smart playback to improve the playback efficiency

### Professional and Reliability

- H.265+ compression effectively reduces the storage space by up to 75%
- Adopt stream over TLS encryption technology which provides more secure stream transmission service

### HD Video Output

- Provide independent HDMI and VGA outputs
- HDMI video output at up to 4K resolution

### Storage and Playback

- Up to 2 SATA interfaces for HDD connection (up to 10 TB capacity per HDD)
- 8-ch synchronous playback

### Network & Ethernet Access

- 1 self-adaptive 10/100/1000 Mbps Ethernet interface
- Hik-Connect for easy network management

## ▪ Specification

<b>Facial Recognition</b>	
Facial Detection and Analytics	Face picture comparison, human face capture, face picture search
Face Picture Library	Up to 16 face picture libraries, with up to 20,000 face pictures in total (each picture ≤ 4 MB, total capacity ≤ 1 GB)
Facial Detection and Analytics Performance	1-ch human face capture
Face Picture Comparison	4-ch face picture comparison alarm
<b>Motion Detection 2.0</b>	
Human/Vehicle Analysis	8-ch
<b>Video and Audio</b>	
IP Video Input	8-ch
Incoming Bandwidth	80 Mbps
Outgoing Bandwidth	160 Mbps
HDMI Output	1-ch, 4K (3840 × 2160)/30 Hz, 2K (2560 × 1440)/60 Hz, 1920 × 1080/60 Hz, 1600 × 1200/60 Hz, 1280 × 1024/60 Hz, 1280 × 720/60 Hz, 1024 × 768/60 Hz
VGA Output	1-ch, 1920 × 1080/60 Hz, 1280 × 1024/60 Hz, 1280 × 720/60 Hz
Video Output Mode	HDMI/VGA independent output
CVBS Output	N/A
Audio Output	1-ch, RCA (2.0 Vp-p, 1 KΩ, using the audio input )
Two-Way Audio	1-ch, RCA (Linear, 1 KΩ)
<b>Decoding</b>	
Decoding Format	H.265/H.265+/H.264+/H.264
Recording Resolution	12 MP/8 MP/6 MP/5 MP/4 MP/3 MP/1080p/UXGA/720p/VGA/4CIF/DCIF/2CIF/CIF/QCIF
Synchronous playback	8-ch
Decoding Capability	AI on: 1-ch@12 MP (30 fps)/2-ch@8 MP (30 fps)/4-ch@4 MP (30 fps)/8-ch@1080p (30 fps) AI off: 2-ch@12 MP (30 fps)/3-ch@8 MP (30 fps)/6-ch@4 MP (30 fps)/12-ch@1080p (30 fps)
Stream Type	Video, Video & Audio
Audio Compression	G.711ulaw/G.711alaw/G.722/G.726/AAC
<b>Network</b>	
Remote Connection	128
Network Protocol	TCP/IP, DHCP, IPv4, IPv6, DNS, DDNS, NTP, RTSP, SADP, SMTP, SNMP, NFS, iSCSI, ISUP, UPnP™, HTTP, HTTPS
Network Interface	1 RJ-45 10/100/1000 Mbps self-adaptive Ethernet interface

<b>Auxiliary Interface</b>	
SATA	2 SATA interfaces
Capacity	Up to 10 TB capacity for each HDD
USB Interface	Front panel: 2 × USB 2.0; Rear panel: 1 × USB 2.0
Alarm In/Out	4/1
<b>General</b>	
Power Supply	12 VDC, 3.3 A
Consumption	≤ 15 W (without HDD)
Working Temperature	-10 °C to 55 °C (14 °F to 131 °F)
Working Humidity	10% to 90%
Dimension (W × D × H)	385 mm × 315 mm × 52 mm (15.2" × 12.4" × 2.0")
Weight	≤ 1 kg (without HDD, 2.2 lb.)
<b>Certification</b>	
FCC	Part 15 Subpart B, ANSI C63.4-2014
CE	EN 55032: 2015, EN 61000-3-2, EN 61000-3-3, EN 50130-4, EN 55035: 2017

**Note:**

Facial recognition and motion detection 2.0 cannot be enabled at the same time.

## Dimension

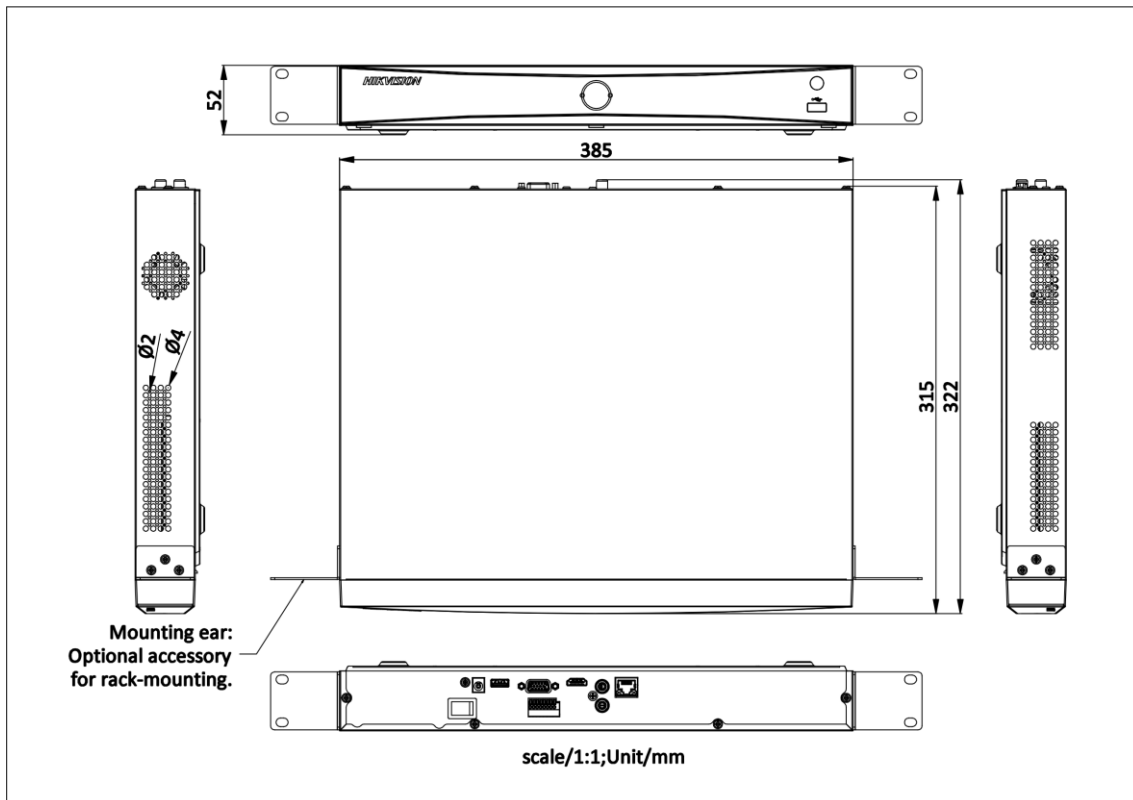

## Physical Interface

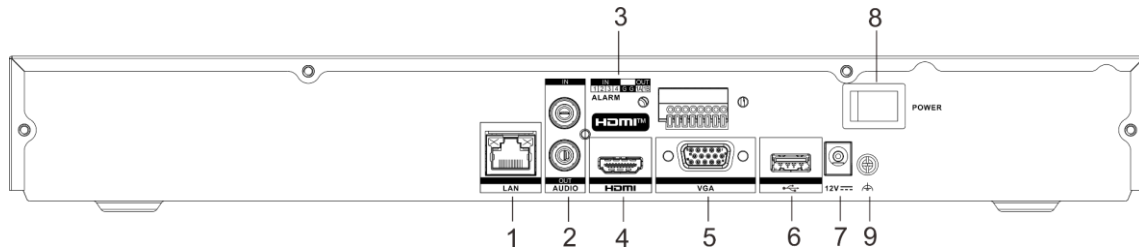

No.	Description	No.	Description
1	LAN network interface	6	USB interface
2	AUDIO IN and AUDIO OUT	7	Power supply
3	ALARM IN and ALARM OUT	8	Power switch
4	HDMI interface	9	GND
5	VGA interface		

## Available Model

DS-7608NXI-K2

### Headquarters

No.555 Qianmo Road, Binjiang District,  
Hangzhou 310051, China  
T +86-571-8807-5998  
www.hikvision.com



Follow us on social media to get the latest product and solution information.

